

# Slotted Optical Flag Switch

## Types OPB680, OPB680-20

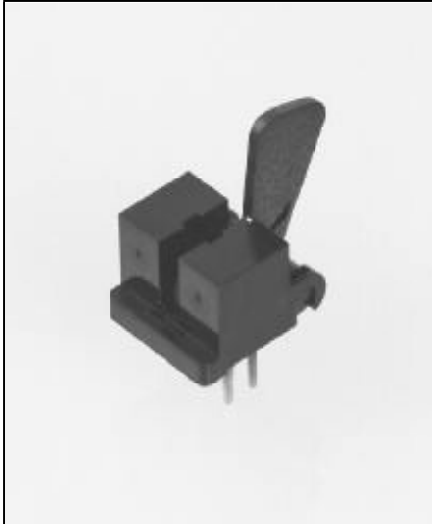

### Features

- Phototransistor output
- Mechanical switch replacement
- Printed circuit board mounting
- Enhanced signal to noise ratio
- Lever force options

### Description

The OPB680 consists of an NPN phototransistor and an infrared emitting diode in a molded plastic housing. The phototransistor has an enhanced low current roll-off which improves contrast ratio and immunity to background irradiance. A lever arm actuated flag interrupts the light beam, switching the output between states that can readily drive logic gates. The lever can be actuated by a passing paper sheet without damaging the paper edge.

The OPB680-20 has the same features as the OPB680 with an increased lever operating force. This feature prevents false triggering due to incidental contact in door sensing and other heavy duty applications.

Customized lever arms and additional spring torques can be designed for specific applications.

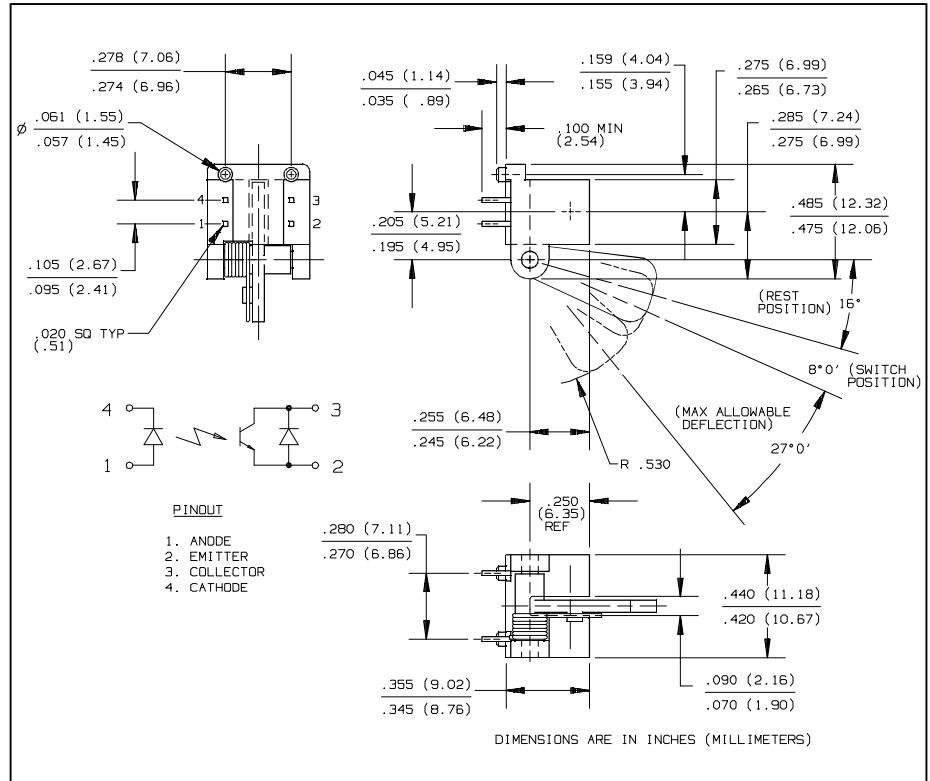

### Absolute Maximum Ratings ( $T_A = 25^\circ\text{C}$ unless otherwise noted)

Storage and Operating Temperature . . . . .  $-40^\circ\text{C}$  to  $+100^\circ\text{C}$   
 Lead Soldering Temperature [1/16 inch (1.6 mm) from case for 5 sec. with soldering iron] . . . . .  $260^\circ\text{C}$

#### Input Diode:

Forward DC Current . . . . . 50 mA  
 Peak Forward Current (1  $\mu\text{s}$  pulse width, 300 pps) . . . . . 3.0 A  
 Reverse DC Voltage . . . . . 3.0 V  
 Power Dissipation . . . . .  $100\text{ mW}^{(2)}$

#### Output Phototransistor:

Collector-Emitter Voltage . . . . . 30 V  
 Emitter Reverse Current . . . . . 10 mA  
 Collector DC Current . . . . . 30 mA  
 Power Dissipation . . . . .  $200\text{ mW}^{(3)}$

#### Notes:

- (1) RMA flux is recommended. Duration can be extended to 10 sec. max. when flow soldering. Max. 20 grams force may be applied to leads when soldering.
- (2) Derate linearly  $1.33\text{ mW}/^\circ\text{C}$  above  $25^\circ\text{C}$ .
- (3) Derate linearly  $2.0\text{ mW}/^\circ\text{C}$  above  $25^\circ\text{C}$ .
- (4) "On" condition exists when the lever arm is in the rest position ( $16^\circ$  from vertical) as shown in the figure.
- (5) "Off" condition exists when the lever arm is deflected clockwise  $8^\circ \pm 3^\circ$  from the rest position ( $16^\circ$  from vertical) as shown in the figure. Maximum allowable deflection is  $35^\circ$  from the rest position.

# Types OPB680, OPB680-20

Electrical Characteristics ( $T_A = 25^\circ\text{C}$  unless otherwise noted)

SYMBOL	PARAMETER	MIN	MAX	UNITS	TEST CONDITIONS
<b>Input Diode:</b>					
$V_F$	Forward Voltage		1.60	V	$I_F = 10\text{ mA}$
$I_R$	Reverse Current		100	$\mu\text{A}$	$V_R = 3.0\text{ mA}$
<b>Output Phototransistor:</b>					
$V_{(BR)CEO}$	Collector-Emitter Breakdown Voltage	30		V	$I_C = 100\ \mu\text{A}$
$I_{ECO}$	Emitter Reverse Current		100	$\mu\text{A}$	$V_{EC} = 0.4\text{ V}$
$I_{CEO}$	Collector-Emitter Dark Current		100	$\mu\text{A}$	$V_{CE} = 5\text{ V}$
<b>Coupled:</b>					
$V_{SAT}$	Saturation Voltage		0.40	V	$I_F = 10\text{ mA}, I_C = 100\ \mu\text{A}$
$I_{C(ON)}$	On-State Collector Current	600		$\mu\text{A}$	$I_F = 10\text{ mA}, V_{CE} = 5\text{ V}$
<b>Mechanical:</b>					
FOP	Operating Force				
	OPB680		1.5	g	Measured at end of lever
	OPB680-20		20	g	Measured at end of lever
Cycles	Operating Cycles	100 K		Cycles	

**Forward Current vs. Forward Voltage Input Diode**

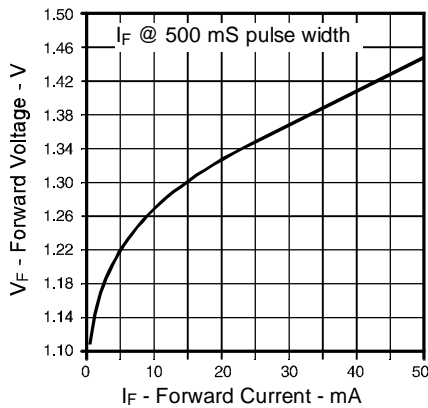

**Collector Dark Current vs. Ambient Temperature**

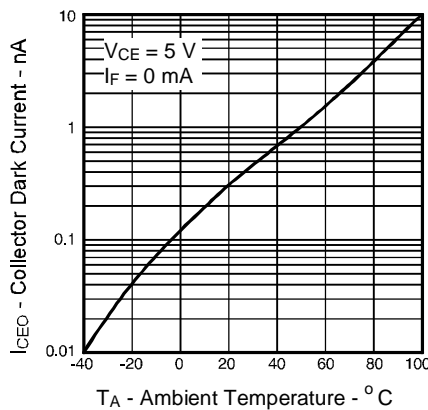

**Normalized Output Current vs. Ambient Temperature**

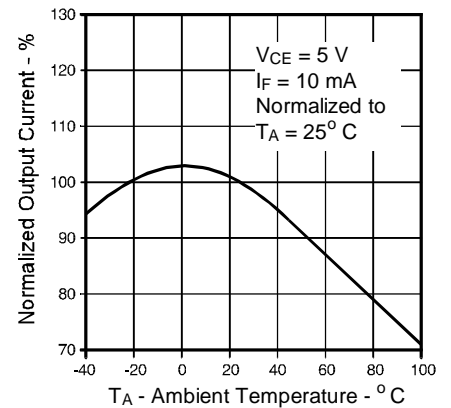

**Rise and Fall Time vs. Load Resistance**

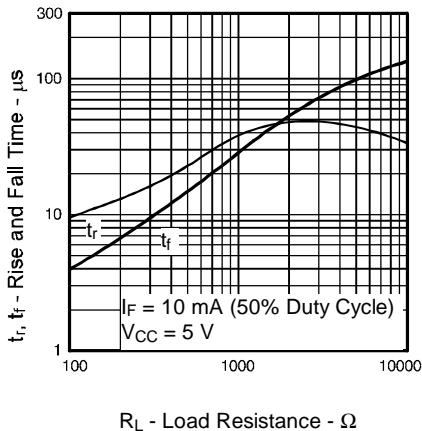

**Normalized Output Current vs. Forward Current**

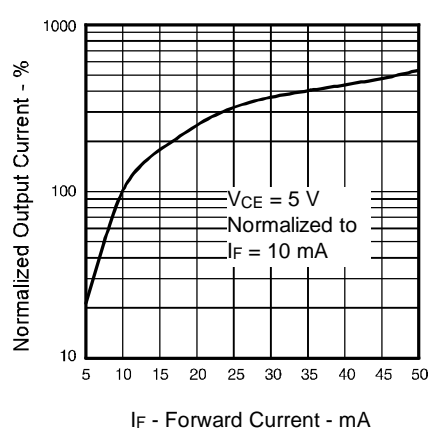

**Normalized Forward Voltage vs. Ambient Temperature**

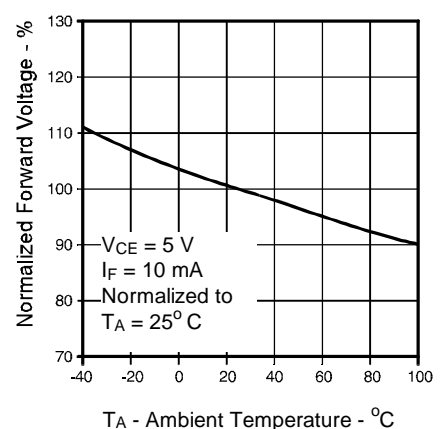

Optek reserves the right to make changes at any time in order to improve design and to supply the best product possible.

Optek Technology, Inc. 1215 W. Crosby Road Carrollton, Texas 75006 (972)323-2200 Fax (972)323-2396